

Deckenanschluss

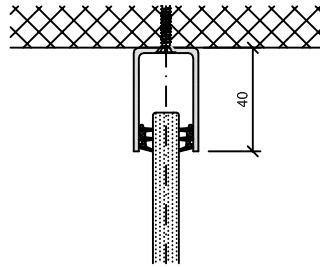

Türe

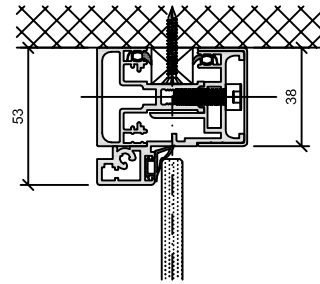

Ecke stumpf

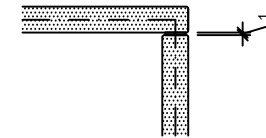

Bodenanschluss

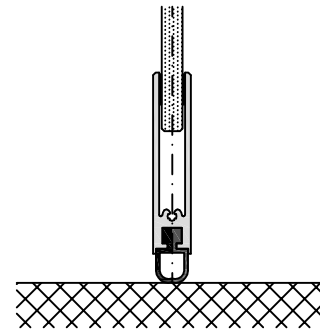
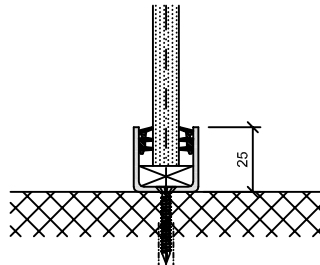

Ecke Gehrung

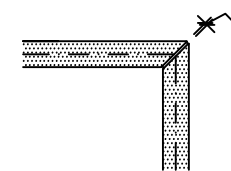

Wandanschluss und Elementstoss

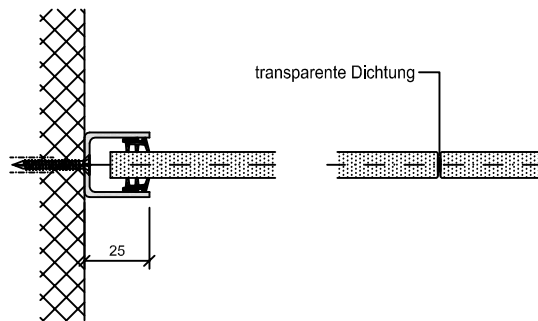

Türe

